

Operating Instructions and Spare Parts List

EasyTronic Control Unit

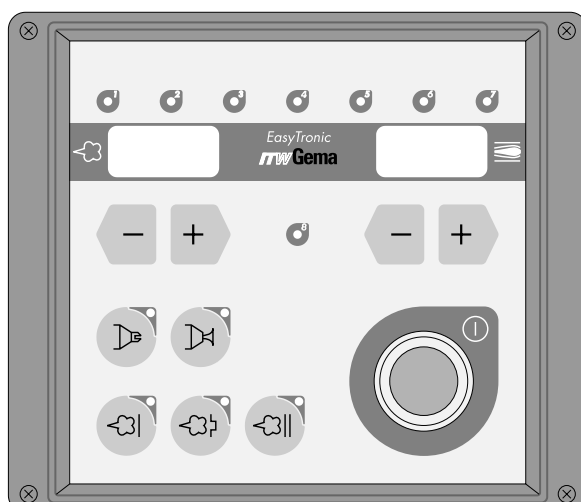

TWGema

CE₀₁₀₂ Ex II (2) D

EASYTRONIC CONTROL UNIT - FRONT VIEW

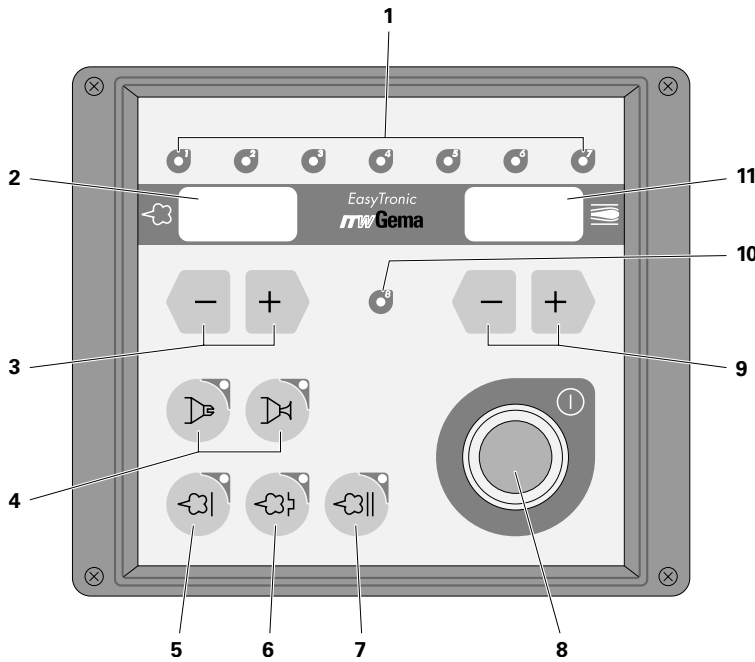

- 1 Diagnostic LEDs
- 2 Powder output display
- 3 Key for setting the powder output
- 4 Electrode rinsing air key
- 5 Application key for flat parts
- 6 Application key for complicated parts
- 7 Application key for overspraying
- 8 On / Off Push button
- 9 Key for setting the total air volume
- 10 Diagnostic LED for High-voltage
- 11 Total air volume display

CONNECTIONS ON THE REAR OF THE EASYTRONIC CONTROL UNIT

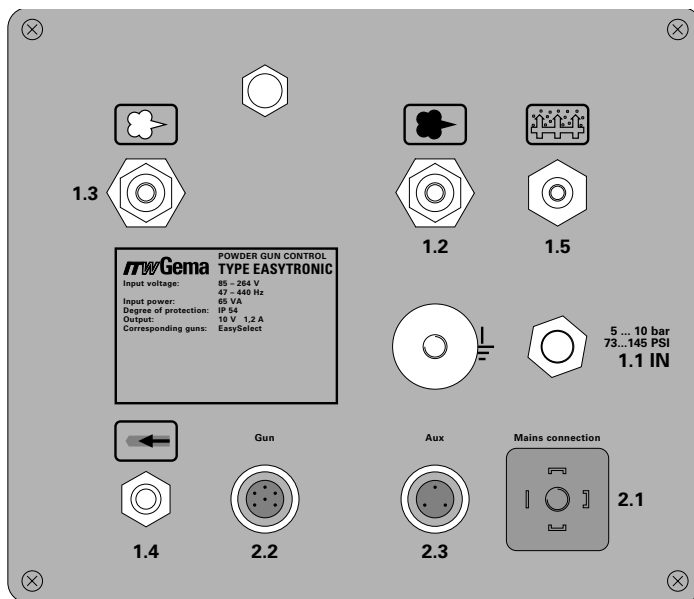

- 1.1 IN Compressed air input
- 1.2 Conveying air connection
- 1.3 Supplementary air connection
- 1.4 Rinsing air connection
- 1.5 Fluidizing air connection
- 2.1 Mains input (85-264 V)
- 2.2 Gun connection for the EasySelect Manual Powder Gun.
PG 1 manual powder guns cannot be connected here!
- 2.3 Output for Vibrator (EASY 1-B only) and Stirrer control unit (EASY 1-S only)
- ⊥ Ground connection

Table of Contents

Directions for use

Safety rules for electrostatic Powder coating

Technical Data - EasyTronic Control unit

EasyTronic Control Unit	1
Field of Application	1
Operating mode	1
Description of the EasyTronic Control unit	2
Installation of the Powder coating equipment	3
Preparation for Start up	4
a) Setting the Operating mode on the Electronic board	4
b) Preparation of the Powder hopper / container	5
c) Switching on the Booth	5
d) Function check	5
Daily Start up	6
a) Setting the Powder output, and Powder cloud	6
Set the Total air volume	6
Select the Powder output volume	6
Select the electrode rinsing	6
b) Powder coating	7
c) Remote control through the Powder gun	7
d) Switching off	7
When the Powder coating equipment is not used for a number of days ..	7
Repairs to Electrical parts of the Control unit	8
a) Replacing fuse(s)	8
b) Replacing the CG 01 Printed Circuit Board	9
c) Replacing the Front plate	10
Dismantle Main switch	10
Repairs to Pneumatic parts in the Control unit	11
a) Replacing a Pneumatic Part	11
Removing the pneumatic tubes	11
Replacing the pneumatic tubes	11
Troubleshooting Guide	12
Pneumatic diagram	14
Block Diagram	15
Display of the Operating Time	16
Spare parts list	17
Ordering Spare parts	17
EasyTronic Control Unit - Pneumatic Parts	18
EasyTronic Control Unit - electrical Parts	20
EasyTronic Control Unit - Accessory	21

Safety regulations for electrostatic manual powder spraying equipment

1 Safety symbols (Pictograms)

This chapter sets out the fundamental safety regulations that must be followed by the user and third parties using the powder spraying equipment. These safety regulations must be read and understood before the powder spraying equipment is used.

The following warnings for ITW Gema operating instructions are shown here with their meanings. The general safety precautions must also be followed as well as the regulations in the operating instructions.



Danger!

Danger due to live electricity or moving parts. Possible consequences: Death or serious injury.



Warning!

improper use of the equipment could damage the machine or cause it to malfunction. Possible consequences: minor injuries or damage to equipment.





Information!

useful tips and other information.

2 Conformity of use

1. The manual powder spraying equipment is built exclusively for the normal application of powder coating according to current recognized technological and safety regulations.
2. Any other use is considered as non-conform. The manufacturer is not responsible for damage resulting from improper use of this equipment; the end-user alone is responsible. If the manual powder spraying equipment is to be used for other purposes or other substances outside of our guidelines then ITW Gema AG should be consulted.
3. Observance of the operating, service and maintenance instructions specified by the manufacturer is also part of conformity of use. The hand held powder spraying equipment should only be used, maintained and started up by trained personnel who are informed about and are familiar with the possible hazards involved.
4. Unauthorized modifications to powder spraying equipment exempts the manufacturer from any liability from resulting damage.
5. The relevant accident prevention regulations, as well as other generally recognized safety regulations, occupational health and structural regulations are to be observed. (see appendix "Standards")
6. Furthermore the country-specific safety regulations must be observed.

Explosion protection	Type of protection	Temperature class
  II (2) D	IP54	T6 (zone 21) T4 (zone 22)

3 Safety Technical Information

3.1 General information

The powder spraying equipment from ITW Gema is safe to operate and is built according to the latest technological specifications. This equipment can be dangerous if it is not used for its specified purpose. It should also be noted that because of this there exists:

- A danger to life and limb of the user or third party.
- A danger of damage to the equipment and other machinery belonging to the user.
- A hazard to the efficient operation of the equipment.

1. The powder spraying equipment should only be started up and used once the operating instructions have been carefully studied.
2. Before every Start-up check the equipment for operational safety (regular servicing is essential)!
3. Safety regulations BGI 764 and VDE regulations DIN VDE 0147, Part 1, must be observed for safe operation.
4. Safety precautions specified by local legislation must be observed.
5. The plug must be disconnected before the machine is opened for repair.
6. Only original ITW-Gema replacement parts should be used, because the explosion protection will also be preserved that way. Damage caused by other parts is not covered by guarantee.
7. If ITW-Gema powder spraying equipment is used in conjunction with machinery from other manufacturers then their safety regulations must also be taken into account.
8. Caution must be exercised when working with a powder/air mixture! A powder/air mixture in the right concentration is flammable! No smoking during powder coating.
9. As a general rule for all powder spraying installations, persons with pacemakers should never enter high voltage areas or areas with electromagnetic fields. Persons with pacemakers should not enter areas with powder spraying installations!



Warning!

We emphasize that the customer themselves is responsible for safe operation of equipment. ITW-Gema is in no way responsible for any resulting damages.

3.2 Safety conscious working

Each person responsible for the assembly, start-up, operation, service and repair of powder spraying equipment must have read and understood the operating instructions and the "Safety" chapter. The operator must ensure that the user has had the appropriate training for powder spraying equipment and is aware of the possible sources of danger.

The control devices for the spray guns must only be set up and used inside of the zone 22, and the spray guns should be used in the zone 21.

3.3 Individual safety regulations for the operating firm and/or operating personnel

1. Any operating method which will negatively influence the technical safety of the powder spraying equipment is to be avoided.
2. The operator is under obligation to check the powder spraying equipment at least once a month for signs of external damage, defects or changes (including the operating characteristics) which could influence safety and to report them immediately.
3. The operator is obliged to check that the powder spraying equipment is only operated when in satisfactory condition.
4. As far as is necessary, the operating firm must ensure that the operating personnel wear protective clothing (e.g. facemasks).
5. The operating firm must guarantee cleanliness and an overview of the workplace with suitable instructions and checks in and around the powder spraying equipment.

3.4 Notes on special types of hazard

3.4.1 Power

High voltage equipment must not be opened - the plug must first be taken out – otherwise there is the danger of electric shock.

3.4.2 Powder

Powder/air mixtures can be ignited by sparks. There must be sufficient ventilation in the powder coating booth. Powder lying on the floor around the powder spraying device is a potentially dangerous source of slipping.

3.4.3 Static charges

Static charges can have the following consequences: Charges from people, electric shocks, sparking. Charges from objects must be avoided – see Earthing

3.4.4 Earthing

All electricity conducting parts and machinery found in the workplace (according to DIN VDE 0745, Part 102) must be earthed 1.5 m either side and 2.5 m around each booth opening. The earthing resistance of each piece of machinery must amount to 1 M Ω . The resistance must be tested on a regular basis. The condition of the machinery surroundings as well as the suspension gear must ensure that the machinery remains earthed. If the earthing of the machinery includes the suspension arrangements then these this must constantly be kept clean in order to keep the necessary conductivity. The appropriate measuring devices must be kept ready in the workplace in order to carry out the testing.

3.4.5 Compressed air

When there are to be longer pauses or stand-still times between working then the powder spraying equipment should be drained of compressed air. There is a danger of injury when pneumatic hoses are damaged and from the uncontrolled release and improper use of compressed air.

3.5 Prohibition of unauthorized conversions and modifications to equipment

All unauthorized conversions and modifications to powder spraying equipment are forbidden for safety reasons.

The powder spraying equipment should not be used if damaged, the faulty part must be immediately replaced or repaired. Only original ITW-Gema replacement parts should be used. Damage caused by other parts is not covered by guarantee.

Repairs must only be carried out by specialists or in ITW-Gema workshops. Unauthorized modifications can lead to personal injury and damage to machinery. The ITW Gema AG guarantee would no longer be valid.

4 Safety requirements for electrostatic powder coating

1. This equipment is dangerous if the instructions in this operating manual are not followed.
2. All electrostatic conductive parts and in particular the machinery, within 5m of the coating equipment must be earthed.
3. The floor of the coating area must conduct electricity (normal concrete is generally conductive).
4. The operating personnel must wear electricity conducting footwear (e.g. leather soles).
5. The operating personnel should hold the gun with bare hands. If gloves are worn, these must also conduct electricity.
6. The supplied earthing cable (green/ yellow) must be connected to the earthing screw of the electrostatic powder spraying hand appliance. The earthing cable must have a good metallic connection with the coating booth, the recovery unit and the conveyor chain and with the suspension arrangement of the objects.
7. The electricity and powder supply to the hand guns must be set up so that they are fully protected against heat and chemical damage.
8. The powder coating device may only be switched on, once the booth has been started up. If the booth cuts out then the powder coating device must be switched off.
9. The earthing of all electricity conducting devices (e.g. hooks, conveyor chains) must be checked on a weekly basis. The earthing resistance must amount to $\leq 1 \text{ M}\Omega$.
10. The control device must be switched off if the hand gun is cleaned or the nozzle is changed. The control device is also to be switched off when filling powder, so that ex atmosphere is not produced unnecessarily.
11. When working with cleaning agents there may be a risk of hazardous fumes. The manufactures information must be observed when using such cleaning agents.
12. The manufacturers instructions and the applicable environmental requirements must be observed when disposing of powder lacquer and cleaning agents.
13. If any part of the spray gun is damaged (broken parts, tears) or missing then it should not be used.
14. For your own safety, only use accessories and attachments listed in the operating instructions. The use of other parts can lead to risk of injury. Only original ITW-Gema replacement parts should be used.
15. Repairs must only be carried out by specialists and under no circumstances should they be carried out in the operating area. All unauthorized conversions and modifications may lead to injury or damage to machinery. The former protection must not be reduced.
16. Conditions leading to dangerous levels of dust concentration in the powder spraying booths or in the powder spraying areas must be avoided. There must be sufficient technical ventilation available, to prevent a dust concentration of more than 50% of the lower explosion limit (UEG) (UEG = max. permissible powder/air concentration) If the UEG is not known then a value of 20 g/m^3 should be used.

5 A summary of the rules and regulations

The following is a list of relevant rules and regulations which are to be observed:

5.1 Guidelines and Regulations, German professional association

BGV A1	General Regulations.
BGV A2	Electrical equipment and material.
BGI764	Electrostatic coating
BGR132	Guidelines for the avoidance of the dangers of ignition due to electrostatic charging (Guideline "Static Electricity")
VDMA 24371	Guidelines for electrostatic coating with synthetic powder ¹⁾ - Part 1 General requirements. - Part 2 Examples of use.

5.2 Leaflets

ZH 1/310	Leaflet on the use of tools in locations where there is danger of explosion. ¹⁾
-----------------	--

5.3 European Standards EN

RL94/9/EG	The approximation of the laws of the Member States relating to apparatus and safety systems for their intended use in potentially explosive atmospheres
EN 292-1 EN 292-2	Machine safety ²⁾
EN 50 014 to EN 50 020 identical DIN VDE 0170/0171	Electrical equipment for locations where there is danger of explosion ³⁾
EN 50 050	Electrical apparatus for potentially explosive atmospheres - Electrostatic hand-held spraying equipment ²⁾
EN 50 053 Part 2	Requirements for the selection, installation and use of electrostatic spraying equipment for flammable materials - Hand-held electrostatic powder spray guns ²⁾
PR EN 12981	Coating plants - Spray booths for application of organic powder coating material - Safety requirements
EN 60529 identical DIN 40050	IP-Type protection: contact, foreign bodies and water protection for electrical equipment. ²⁾
EN 60 204 identical DIN VDE 0113	VDE Regulations for the setting up of high-voltage electrical machine tools and processing machines with nominal voltages up to 1000 V ³⁾

5.4 VDE (Association of German Engineers) Regulations

DIN VDE 0100	Regulations for setting-up high voltage equipment with nominal voltages up to 1000 V. ⁴⁾
DIN VDE 0105	VDE Regulations for the operation of high voltage equipment. ⁴⁾
Part 1	General regulations.
Part 4	Supplementary definitions for stationary electrical spraying equipment.
DIN VDE 0147	Setting up stationary electrostatic spraying equipment ⁴⁾
Part 1	
DIN VDE 0165	Setting up electrical equipment in locations where there is a danger of explosion. ⁴⁾

Source:

¹⁾ Carl Heymanns Verlag KG, Luxemburger Strasse 449, 5000 Köln 41, or from the appropriate employers association.

²⁾ Beuth Verlag GmbH, Burggrafenstrasse 4, 1000 Berlin 30

³⁾ Generalsecretariat, Rue Bréderode 2, B-1000 Brüssel, or the appropriate national committee.

⁴⁾ VDE Verlag GmbH, Bismarckstrasse 33, 1000 Berlin 12

TECHNICAL DATA - EASYTRONIC CONTROL UNIT*Mains connection:*

Input voltage:	90 - 264 V
Frequency:	47 - 440 Hz
Nominal output voltage (to gun):	max. 12 V _s
Nominal output current (to gun):	max. 1 A
Type of protection:	IP 54
Temperature range:	0 °C to +40 °C (+32 °F to +104 °F)
Approval:	

Pneumatic Data

Main compressed air input:	B.S.P. 1/4" (Female)
Max. Input pressure:	10 bar
Min. Input pressure:	6 bar
Max. water content of the compressed air:	1.3 g/m ³
Max. oil vapour content of the compressed air:	0.1 mg/kg

Dimensions:

Width:	248 mm
Depth:	250 mm
Height:	174 mm
Weight:	5.2 kg

**IMPORTANT**

The EasyTronic Control Unit can only be used with the EasySelect manual gun.

EASYTRONIC CONTROL UNIT

Field of Application

The electrostatic EasyTronic Control Unit is designed exclusively for the controlling powder coating with the EasySelect manual powder gun. This equipment is not to be used for any other purpose. Any damage resulting from its misuse is not the responsibility of the manufacturer, the entire risk is carried by the customer alone.

All settings for efficient powder coating have been made simple and reproducible on the EasyTronic. The built-in electronics permit exact setting of the optimum powder output, and the values set can be seen on the digital display windows and can even be checked from a distance. According to the selected application mode, the spray voltage is set automatically and spray current is limited automatically. The EasyTronic Control Unit can be connected to all usual mains voltages.

For a better understanding of the relationships in powder coating it is recommended to read the operating instructions of other components, thoroughly, so as to be familiar with their functions also.

Operating mode

The EasyTronic Control Unit is foreseen as standard for operation with all manual coating equipment in the EASY range. The desired functionality must, however, be determined by means of a "jumper" on the electronic board inside the control unit. If the control unit is supplied as a component of an EASY unit, then the "jumper" will be correspondingly set in the correct position at the factory.

In every other case, it is recommended to check the setting of the "jumper" (see also the corresponding section "Setting the operating mode on the electronic board").

 **NOTICE**

An incorrectly set "jumper" can lead to malfunctioning or to reduced functioning of the Vibration, Fluidization or Stirrer!

DESCRIPTION OF THE EASYTRONIC CONTROL UNIT

The operating panel of the EasyTronic control unit consists of 4 main areas: *Diagnostic LEDs*, *Displays*, *"+/-" Keys*, and *Function keys*.

- 

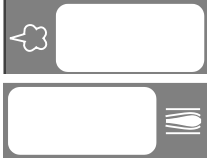
1. The **Diagnostic LEDs** 1–8 serve to show the status of the equipment, and equipment faults. Detailed information is found in the "Troubleshooting Guide"
- 

2. There are two **Displays** with whose help the following values are displayed:

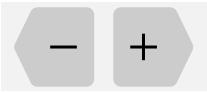
 - **Powder output** (Setting range 0–100 %) Powder output in % always refers to the max. possible output volume to the total air volume setting.
 - **Total air volume** (Setting range 1.6–6.0 Nm³/h)
- 

3. The **Keys "+"** and **"–"** are for setting the powder output, and the total air volume used.

If a key is pressed once, the value is increased or decreases, respectively, by one step. If a key is pressed continuously, the setting change rapidly.
- 

4. The **Function keys** have the following functions:

 - **Electrode rinsing air for flat jet nozzles**
 - **Electrode rinsing air for round jet nozzles**

When a key is pressed once, the corresponding function is activated, and the corresponding LED illuminates.

If a key with an illuminated LED is pressed for longer than 1 second, the function is deactivated.

ITW Gema recommends leaving the electrode rinsing air switched on, but can, however, remain switched off for applications with very small amounts of powder.

 - **Application keys:** With these keys the electrostatic (High-voltage, and current) are automatically set so that the setting for the selected application is the optimum.
 - Settings for flat parts
 - Settings for complicated parts with depressions
 - Settings for coating parts already coated

High-voltage and current can be deactivated, when the corresponding key pad with the illuminated LED is pressed for longer than 1 second.

The EasyTronic control unit is switched on and off with a **Push button**. If the equipment is switched on, the yellow lamp is illuminated.

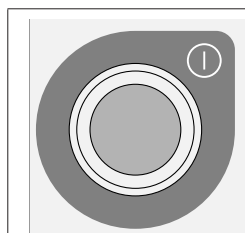

Figure 1

When the equipment is first switched on the preselected factory settings displayed:

60%
Flat jet rinsing

4.0 Nm³/h
Complicated parts

After switching the equipment off (also when the equipment is disconnected from the Mains) the actual settings are retained.

INSTALLATION OF THE POWDER COATING EQUIPMENT

1. Connect the hose for the compressed air supply from compressed air circuit directly to the main air connection - **1.1 IN** on the rear of the control unit (female thread: 1/4" B.S.P.).

NOTICE

The compressed air must be free from oil and water.

2. Connect the black hose for the fluidizing air (if required) to the corresponding output (**1.5**) on the rear of the control unit.
3. Fit the grounding connection cable on the control unit with the grounding screw $\frac{1}{4}$, and the 5 m long grounding cable with the clamping clip to the booth or on the hanger device.
4. Connect the gun cable with the 7 pin plug on the rear of the control unit on the socket - **2.2** (Gun).

IMPORTANT

PG 1 Manual powder guns cannot be connected!

5. Connect the hose for rinsing air to the rinsing air output - **1.4** and to the powder gun.
6. Plug the injector in, and connect the powder hose to the injector and to the powder gun.
7. Connect the red hose for the conveying air to the corresponding output - **1.2** on the rear of the control unit and to the injector.
8. Connect the black hose for the supplementary air to the corresponding output - **1.3** on the rear of the control unit and to the injector.
9. Connect the Mains cable on the socket - **2.1**.

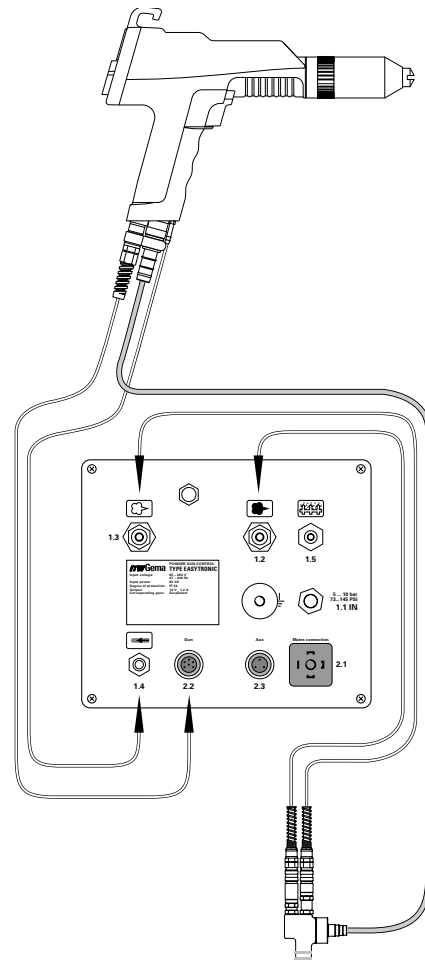

Figure 2

PREPARATION FOR START UP

a) Setting the Operating mode on the Electronic board



The Mains plug of the EasyTronic Control Unit must be disconnected from the Mains before starting work!

The desired operating mode must be determined with a so-called "jumper" the electronic board inside the control unit.



If the control unit is supplied as a component of an EASY unit, then the "jumper" will be correspondingly set in the correct position at the factory.

1. Unscrew the screws on the front of the housing.



Figure 3

2. Hold the front plate with one hand and fit the "jumper" in the desired position:

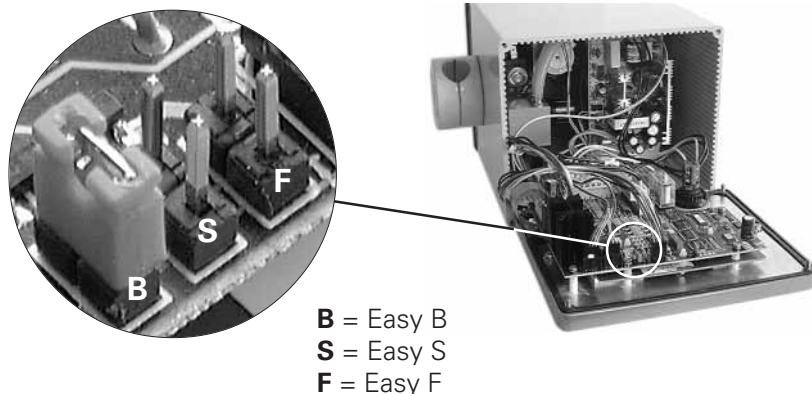



Figure 4

3. Replace the front plate and tighten the screws.
Do not over-tighten the screw!
4. Reconnect the Mains cable.
5. Carry out a calibration:

- a) Hold all Application keys  pressed and simultaneously press the Main switch.

The equipment carries out a calibration. An increase in noise can be heard inside the control unit. Both displays show 888. After about 20 seconds the equipment is ready for operation and returns to the factory setting.

b) Preparation of the Powder hopper / container

Prepare the powder hopper or the powder container according to the type of manual equipment to be used.
(Follow the instructions in the corresponding operating manuals)

c) Switching on the Booth

Switch on the powder coating booth according to the corresponding operating instructions.

d) Function check

1. Press the push button on the control unit. The yellow control lamp in the switch illuminates.
The equipment carries out a calibration, when it comes **direct from the factory**. An increase in sound can be heard inside the control unit. Both displays show *888*. The equipment is ready for operation after about 20 seconds and switches to the factory settings.
2. Take the powder gun in the hand and point it at a **grounded** object in the booth, distance approx. 20 cm.
3. Press the gun trigger.
LED No. 8 illuminates. The High-voltage is switched on and powder is conveyed.

If all tests are positive, the control unit, and the powder gun are ready for operation. If one of the functions does not operate as expected, check this in the "Troubleshooting Guide", on page 12.

DAILY START UP**a) Setting the Powder output, and Powder cloud**

The powder output is dependent on the powder, and the setting of the total air volume.

Set the Total air volume

1. Switch on the control unit.
2. Set the total air volume (for more information, also see the EasyFlow Operating Instructions).

The total air volume is dependent on the powder hose length, the number of turns of the hose, the hose diameter, and the object being coated.

The value set for the total air volume can be left as it is, as long as the same powder hose is used. If the hose length and/or the hose diameter are changed, then the total air volume must be reset.

Select the Powder output volume

3. Select the powder output volume according to the desired coating thickness.

The selection takes place with the aid of the + or – keys, either on the control unit or on the rear of the powder gun.

To start, a standard setting of 60% is recommended. The total air volume is maintained constant automatically.

4. Check the fluidizing of the powder
5. Point the powder gun into the booth and press the powder gun trigger

Select the electrode rinsing

6. Select the correct electrode rinsing

When using flat jet nozzles:

- Press the key with the corresponding symbol . The LED of the corresponding key illuminates.

When using round jet nozzles with air rinsed deflector plates:

- Press the key with the corresponding symbol . The LED of the corresponding key illuminates.

7. Adjust the powder cloud to a test object

When using flat jet nozzles:

- Unscrew the threaded sleeve approximately 45°, so that the flat jet nozzle (or extension) can only be turned slightly
- Turn the flat jet nozzle to the desired axial position
- Tighten the threaded sleeve again

When using round jet nozzles with air rinsed deflector plates

- Exchange the deflector plate (ø 16, 24, and 32 mm supplied with the powder gun)

b) Powder coating

Make sure that all electrically conductive parts within 5 m of the coating booth are grounded!

1. Take the powder gun in hand and point it into the coating booth, however, do not point it at an object to be coated yet
2. Select the application setting

Press the corresponding application key  on the control unit. The LED of the corresponding key illuminates.

3. Press the powder gun trigger
4. Coat the object(s)

c) Remote control through the Powder gun

The different functions can be remotely controlled with the aid of the + and – keys on the rear of the powder gun:

1. Select the application setting

*Press the + and – keys on the powder gun **simultaneously***

Check by observing the LED display on the powder gun:

Red = Flat parts

Green = Complicated parts

Red/Green (alternating) = Spraying over

2. Change the powder output

Press the + or – keys on the powder gun. The powder output is correspondingly increased or decreased.

d) Switching off

1. Release the powder gun trigger
2. Switch off the control unit

The settings for high-voltage, rinsing air, and powder output are retained.

When the Powder coating equipment is not used for a number of days:

1. Remove the Mains plug from the Mains
2. Clean the coating equipment, see corresponding operating instructions
3. Turn off the main compressed air supply

REPAIRS TO ELECTRICAL PARTS OF THE CONTROL UNIT



The Mains plug of the EasyTronic Control Unit must be disconnected from the Mains before starting work!

a) Replacing fuse(s)

1. Unscrew the screws on the front of the housing.
2. Hold the front plate with one hand and remove the fuse(s) (quick-acting) from the fuseholder and replace with a new one.

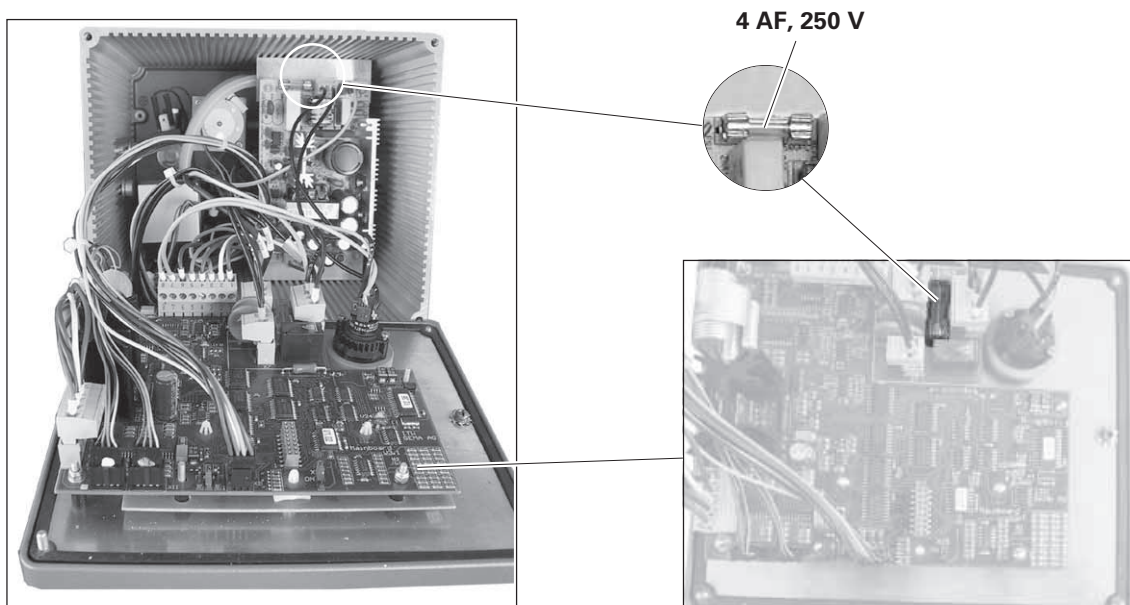



Figure 5

3. Replace the front plate.
Do not over-tighten the screws!
4. Reconnect the Mains cable.
5. Carry out a calibration:

a) Hold all Application keys  pressed and simultaneously press the Main push button.

The equipment carries out a calibration. An increase in noise can be heard inside the control unit. Both displays show 888. After about 20 seconds the equipment is ready for operation and returns to the factory setting.

b) Replacing the CG 01 Printed Circuit Board

1. Disconnect all electrical and pneumatic connections on the rear of the control unit.
2. Loosen the clamping element, dismantle the control unit and place on an level surface.
3. Unscrew the screws on the front of the housing.
4. Press the spacers together with pointed pliers and remove the printed circuit board
5. Remove the plug from the defective board and replace it on the new board.
6. Place the new board on the spacers and push them until they snap into place.
7. Reassemble the control unit in reverse order as described above.

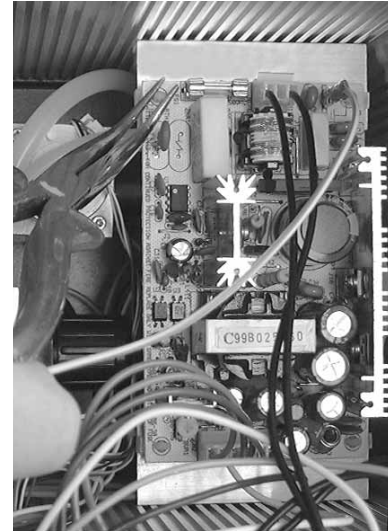



Figure 6

8. Reconnect the Mains cable
9. Carry out a calibration:
 - a) Hold all Application keys  pressed and simultaneously press the Main push button.

The equipment carries out a calibration. An increase in noise can be heard inside the control unit. Both displays show 888. After about 20 seconds the equipment is ready for operation and returns to the factory setting.

If there are any problems or uncertainties, please contact a ITW Gema Service Centre.

c) Replacing the Front plate

Dismantle Main switch

1. Disconnect all electrical and pneumatic connections on the rear of the control unit.
2. Loosen the clamping element, dismantle the control unit and place on an level surface.
3. Unscrew the screws on the front of the housing.
4. Disconnect all plugs from the front plate.
5. Unscrew the screws on the black ring and unscrew the ring.
6. Push the switch through the hole.



Figure 7

7. Unscrew the aluminium ring (A) and pull the push button out of the front plate.

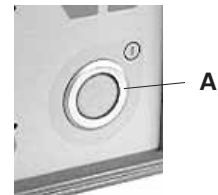

Figure 8

8. Replace the front plate.
9. Fit the plugs to the new front plate.



With the plug **X10**, take note of the white marking!

10. Reassemble the front plate and control unit in the reverse order as described above.

Do not over-tighten the screw!

11. Reconnect the Mains cable.
12. Carry out a calibration:

- a) Hold all Application keys  pressed and simultaneously press the Main push button.

The equipment carries out a calibration. An increase in noise can be heard inside the control unit. Both displays show 888. After about 20 seconds the equipment is ready for operation and returns to the factory setting.

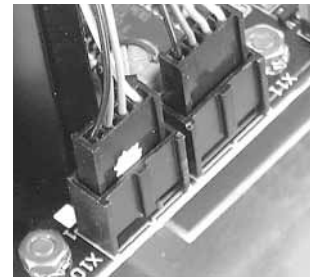

Figure 9

If there are any problems or uncertainties, please contact a ITW Gema Service Centre.

REPAIRS TO PNEUMATIC PARTS IN THE CONTROL UNIT

a) Replacing a Pneumatic Part

1. Disconnect all electrical and pneumatic connections on the rear of the control unit.
2. Loosen the clamping element, dismantle the control unit and place on an level surface.
3. Unscrew the screws on the front of the housing.
4. Remove all pneumatic tubes from the part to be replaced (see below).
5. Dismantle the defective part and replace.
6. Reconnect the pneumatic tubes (see below).
7. Reassemble the control unit in the reverse order as described above.

If there are any problems or uncertainties, please contact a ITW Gema Service Centre.

Removing the pneumatic Tubes

Before exchanging pneumatic parts all tube connections should be removed. This is done by pushing the pressure ring back, with the thumb nail, on the quick-release fitting of the tube connector. The tubing can now be withdrawn.

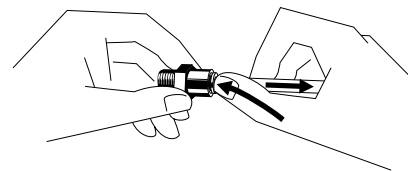

Figure 10

Refitting the pneumatic tubes

This is done by pushing the plastic tubing as far as it will go into the quick-release fitting of the hose connector. The hose is now fixed securely.

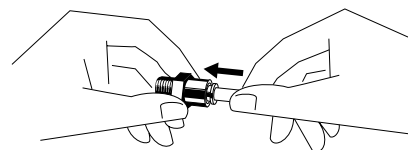

Figure 11

TROUBLESHOOTING GUIDE

The diagnosis LEDs 1-7 illuminate green when switched on, and LED 8 remains unilluminated. It illuminates red when the gun trigger is pulled.

Fault	Cause	Remedies
LED 1-3 not illuminated	Mains supply unit defect	Replace Mains supply unit
LED 4 illuminates red	Main valve defect	Replace main valve spool
LED 5 illuminates red	<ul style="list-style-type: none"> - Gun not connected - Gun plug, gun cable or gun cable connection defect - Remote control on the gun defect 	<p>Connect the gun</p> <p>Replace corresponding part or send in for repair</p> <p>Exchange remote control (gun cover)</p>
LED 6 illuminates red	Solenoid for rinsing air of the flat jet nozzle defect	Replace solenoid valve spool
LED 7 illuminates red	Solenoid for rinsing air of the round jet nozzle defect	Replace solenoid valve spool
LED 8 not illuminated, in spite of the trigger being pulled and the LED 5 illuminates green.	Gun plug, gun cable or gun connection defect	Replace corresponding part or send in for repair
The gun LED remains unilluminated, in spite of the trigger being pulled, and the LED 8 illuminates red.	<ul style="list-style-type: none"> - Gun plug, gun cable or gun connection defect - Remote control on the gun defect 	<p>Replace corresponding part or send in for repair</p> <p>Exchange remote control (gun cover)</p>
Powder does not adhere to the object, in spite of the trigger being pulled, and the gun sprays powder, the gun LED, and the LED 8 are illuminated.	<ul style="list-style-type: none"> - High-voltage and current deactivated - High-voltage cascade defect. - The objects are poorly grounded. 	<p>Press the selection key (Application key)</p> <p>Send the gun in for repair</p> <p>Check grounding, see also "Safety rules"</p>
The control lamp in the push button does not illuminate in spite of the control unit being switched on.	<p>No current:</p> <ul style="list-style-type: none"> - Control unit is not connected to the Mains. <p>In the equipment:</p> <ul style="list-style-type: none"> - Bulb burnt out. - Power pack defect 	<p>Connect the mains cable to the unit</p> <p>Replace</p> <p>Replace</p>

(continued)

Troubleshooting Guide (cont.)

Faults	Causes	Remedies
<p>The powder is not fluidized.</p>	<p>No compressed air present</p> <ul style="list-style-type: none"> - Reducing valve closed - Reducing valve defect 	<p>Connect the equipment to the compressed air supply</p> <p>Open</p> <p>Replace</p>
<p>The gun does not spray powder in spite of the control unit being switched on and the gun trigger being pressed</p>	<p>No compressed air present</p> <ul style="list-style-type: none"> - Injector, check valve or nozzle on the injector, powder hose or gun clogged - Nozzle in the injector clogged - Nozzle not fitted - Fluidizing does not function <p>No conveying air:</p> <ul style="list-style-type: none"> - Reduction valve defect - Solenoid valve defect - Electronic in the front plate defect 	<p>Connect the equipment to the compressed air supply</p> <p>Clean corresponding part</p> <p>Replace</p> <p>Fit nozzle</p> <p>See above</p> <p>Replace</p> <p>Replace</p> <p>Replace, send in for possible repair</p>

PNEUMATIC DIAGRAM

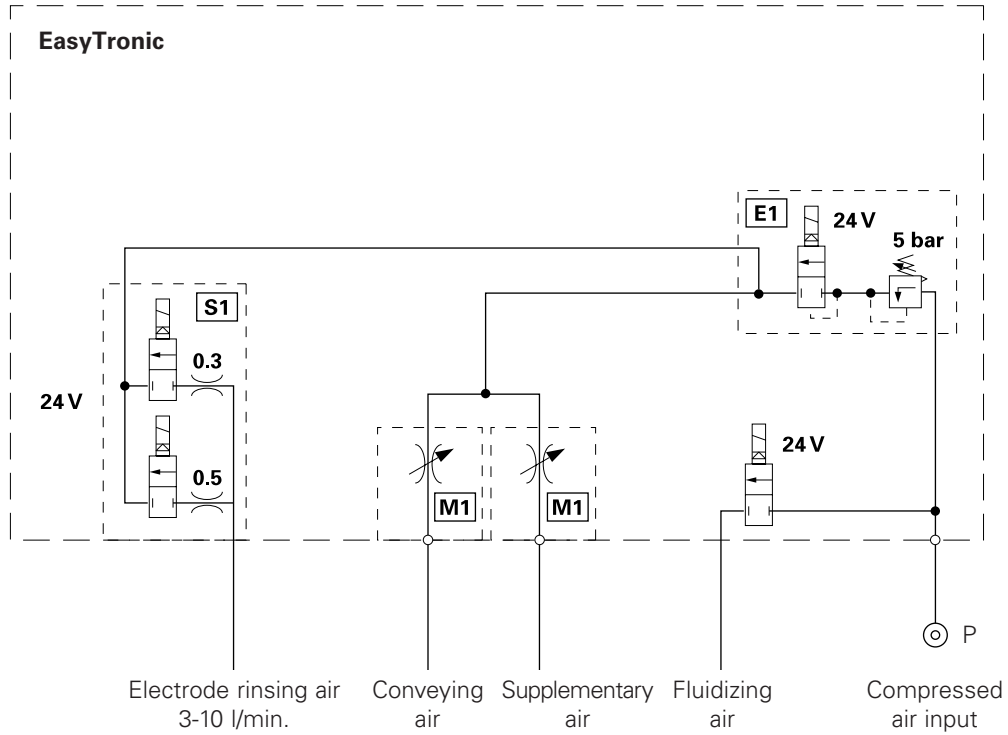

S1 = Rinsing air unit
M1 = Throttle motor
E1 = Input unit

Figure 12

BLOCK DIAGRAM

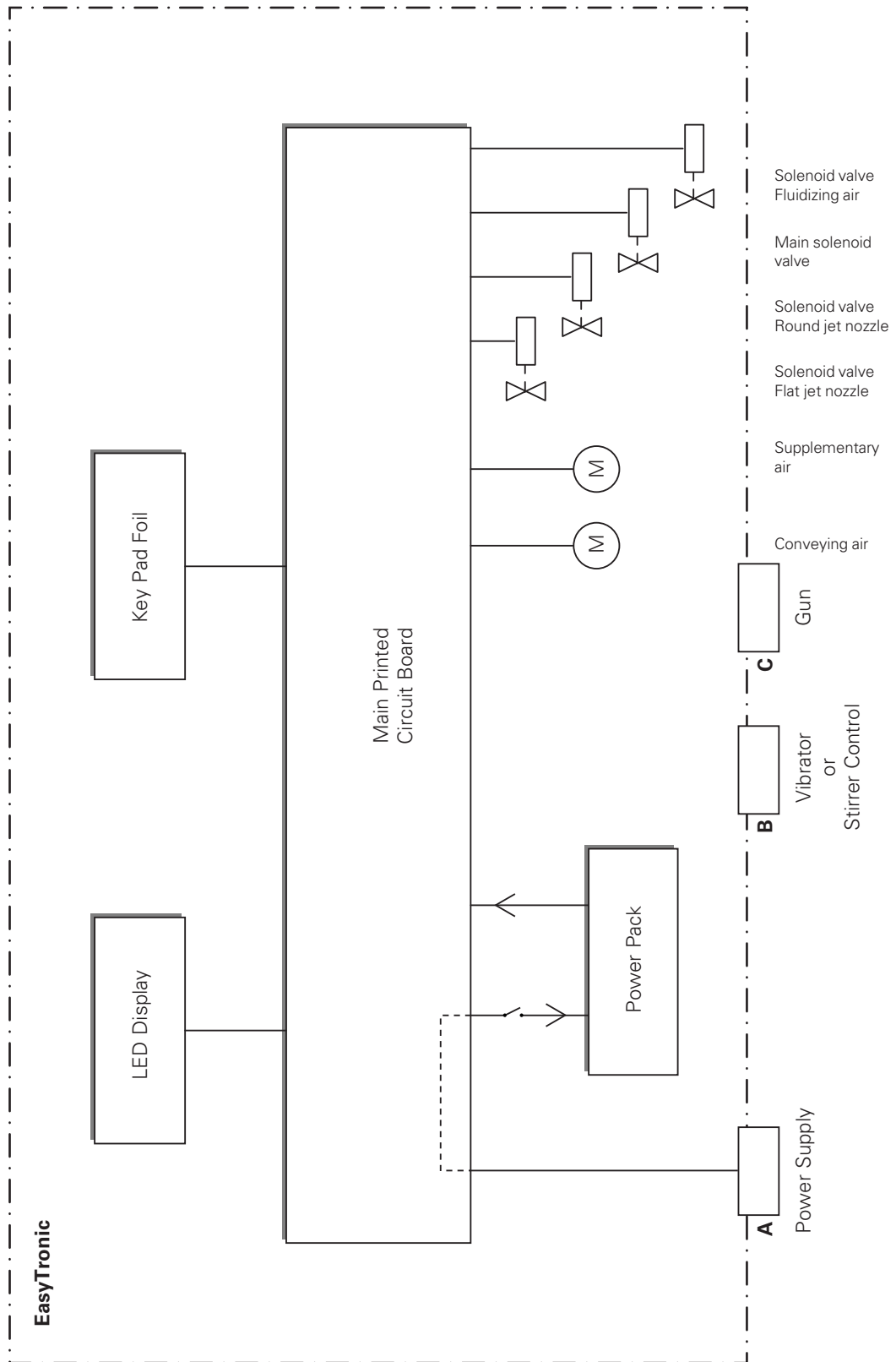



Figure 13

DISPLAY OF THE OPERATING TIME

A software type Timer is built into the EasyTronic Control Unit which gives information about how long the control unit has been used for coating.

In order to use this function the unit must be switched on and **both rinsing air keys**  **must be pressed simultaneously.**

This switches the display and the operation time can be read.

The display shows the hours, with a definition of 1/10 h = 6 mins.

The maximum operating time is 99999.9 h.

The Timer cannot be reset.

SPARE PARTS LIST

Ordering Spare parts

When ordering spare parts for powder coating equipment, please indicate the following specifications:

1. Type and serial number of your powder coating equipment
2. Order number, quantity, and description of *each* spare part

Example:

1. **Type** *EasyTronic*, **Serial No.:** *XXX XXX*
2. **Order No.:** *201 073, 5 pieces, Fine wire fuse*

When ordering cable and hose material the length required must be given.

The spare part numbers of yard/meter ware always begins with 1.. ... and are always marked with an * in the spare parts list.

Wear parts are always marked with a #.

All dimensions for plastic powder hoses are given as external diameter (o/d) and internal diameter (i/d):

e. g. \varnothing 8 / 6 mm, 8 mm outside diameter / 6 mm inside diameter (i/d).

EASYTRONIC CONTROL UNIT - PNEUMATIC PARTS

2	Valve support	265640
5	Pressure regulating valve - 5 bar (preset)	262269
6	Solenoid valve - 1/4" - NW 8 mm, 24 VDC	262307
7	Solenoid valve - 1/8" NW - 1.6 mm, 24 VDC	262285
8	Solenoid valve spool - 24 VDC	262293
11	Seal	262900
12	Drive unit	375713
13	Rinsing air unit - S1	375730
14	Aluminium Block without solenoid	263869
15	Solenoid	263850
28	T-Connection - \varnothing 8 - \varnothing 8 - \varnothing 8 mm	258040
29	Plastic hose - \varnothing 8 / 6 mm	100005*

* Please indicate length required

Wear parts

EasyTronic Control Unit - Pneumatic Parts

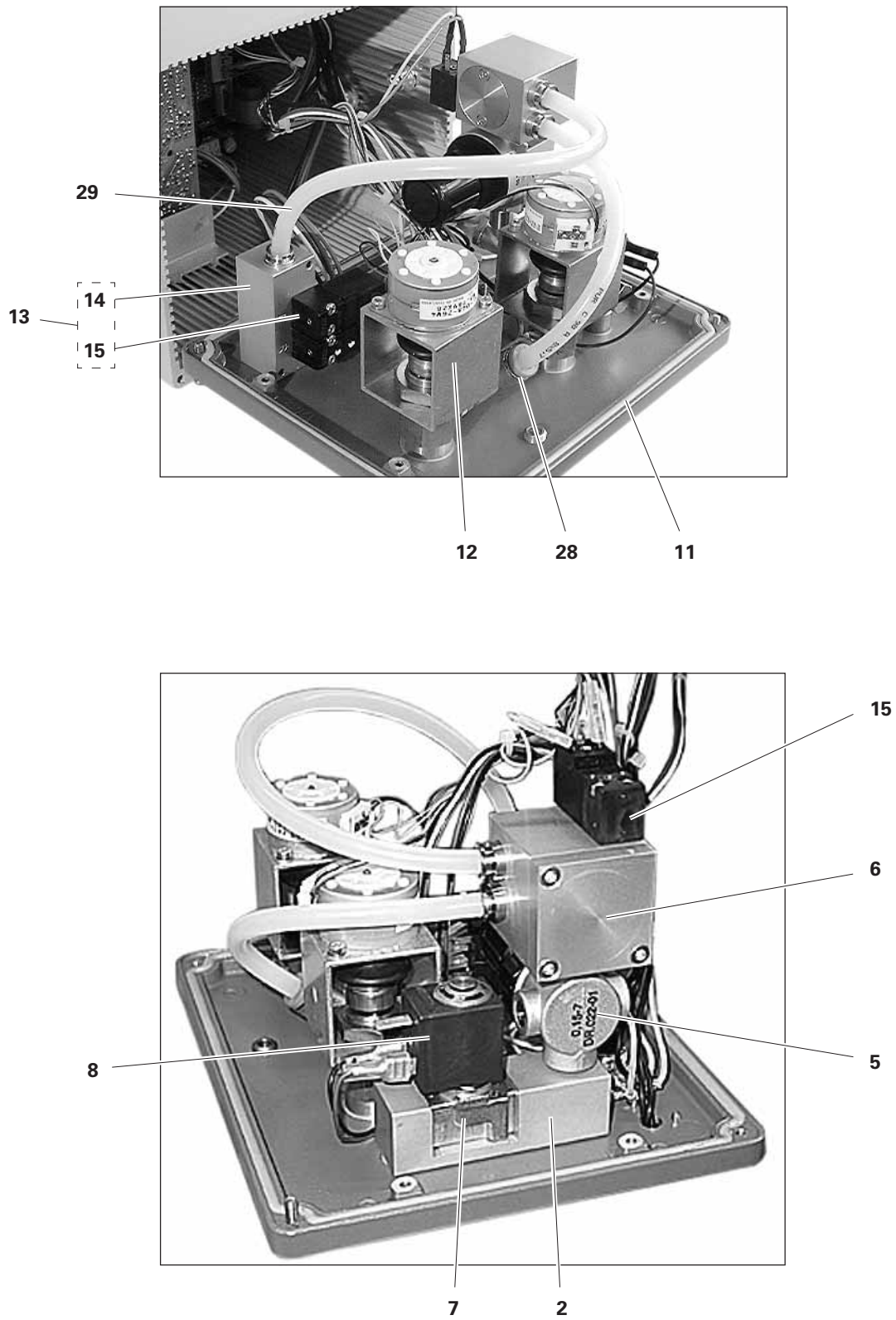
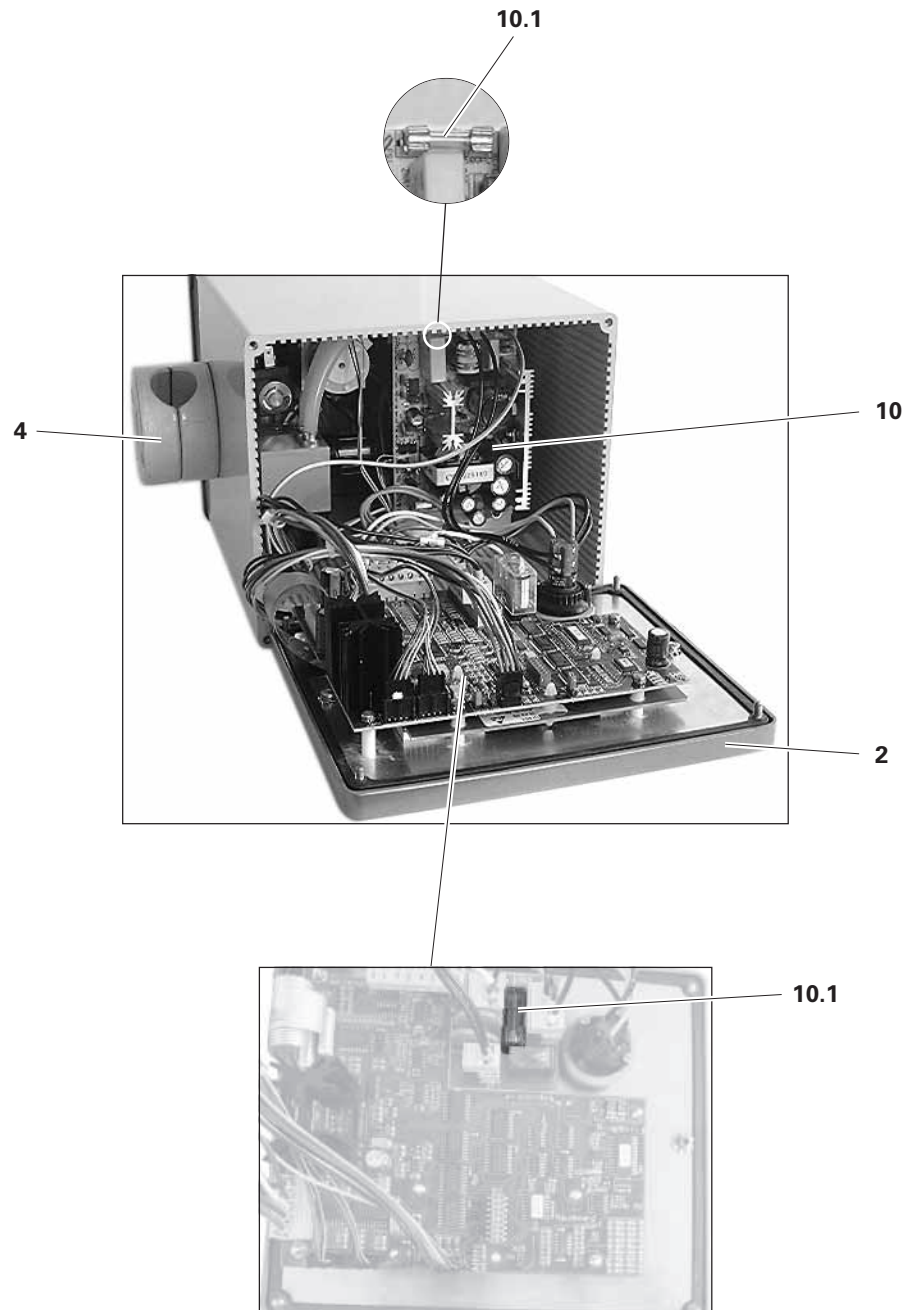

Figure 14

EASYTRONIC CONTROL UNIT - ELECTRICAL PARTS

2	Front plate - complete	375 799
4	Clamping element - complete - ø 30 mm	376 183
10	Printed circuit board CG 01	374 059
10.1	Fuse - 4 AF, 250 V	262 897



* Please indicate length required

Figure 15

EASYTRONIC CONTROL UNIT - ACCESSORY

The transparent protective cover can be simply snapped onto the EasyTronic Front Panel and protects it from contamination and damage. All key pads (incl. the On/Off Switch) can be operated through the protective cover.

Snap-on Protective Cover (set of 5 pieces)

265284



Figure 16

Documentation EasyTronic

© Copyright 2000 ITW Gema AG., CH-9015 St. Gall
All rights reserved.

This publication is protected by copyright. Unauthorized copying is prohibited by law. No part of this publication may be reproduced, photocopied, translated, stored on a retrieval system or transmitted in any form or by any means, for any purpose, neither as a whole nor partially, without the express written consent of ITW Gema AG.

OptiTronic, OptiGun, EasyTronic, EasySelect, EasyFlow and SuperCorona are registered trademarks of ITW Gema AG.
OptiMatic, OptiMove, OptiMaster, OptiPlus, OptiMulti and Gematic are trademarks of ITW Gema AG.

All other product names are trademarks or registered trademarks of their respective holders.

Reference is made in this manual to different trademarks or registered trademarks. Such references do not mean that the manufacturers concerned approve of or are bound in any form by this manual. We have endeavoured to retain the preferred spelling of the trademarks, and registered trademarks of the copyright holders.

To the best of our knowledge and belief, the information contained in this publication was correct and valid on the date of issue. ITW Gema AG makes no representations or warranties with respect to the contents or use of this publication, and reserves the right to revise this publication and make changes to its content without prior notice.

Printed in Switzerland

ITW Gema AG
Mövenstrasse 17
9015 St. Gall
Switzerland

Phone: +41-71-313 83 00
Fax: +41-71-313 83 83
E-mail: info@itwgema.ch